

VENTILCONVETTORE A CASSETTA
WATER CASSETTE UNIT
KALTWASSER DECKEN-KASSETTE

Mod. PS-CL PS-CLE



Scheda tecnica – Data sheet

 Made in Italy

CARATTERISTICHE GENERALI - DESCRIPTION – BESCHREIBUNG

Le unità idroniche a soffitto **PS-CL** con il loro moderno design, la flessibilità di regolazione, la semplicità di manutenzione e la massima silenziosità rappresentano il risultato di accurate analisi per l'ottenimento di un articolo innovativo, adattabile a qualsiasi ambiente ed arredamento, che risponde alle molteplici esigenze estetiche e funzionali. Le dimensioni si adattano perfettamente alla modularità dei pannelli per controsoffitti. Disponibili in due grandezze 600x600 mm (PS050- PS094) e 1200x600 mm (PS100-154) ed infine abbiamo introdotto nella nostra gamma la NUOVA versione con batteria a 4 Ranghi, che permette di raggiungere rese molto più performanti, aumentando la capacità di un 20%.

Proponiamo inoltre una nuova versione di cassetta: **PS-CLH** caratterizzata da uno speciale sviluppo verticale dello chassis e progettata in modo da permettere lo scarico condensa in modo naturale, evitando così l'installazione di una pompa estrazione condensa. Queste unità sono adatte per l'installazione in ambienti in cui sono richiesti particolari requisiti igienico-sanitari, dove è necessario facilitare ridurre gli interventi di manutenzione o dove è richiesto un valore contenuto di emissioni sonore (ospedali, case di riposo, scuole, biblioteche ..). Nella nostra gamma presentiamo la versione con motori AC, il modello **PS-CL** o con motori EC, il modello **PS-CLE**. La versione con motori EC consente un risparmio energetico fino al 50% rispetto alla versione standard. Oltre al pannello standard in ABS, offriamo anche un pannello in lamiera verniciato con apertura magnetica, che grazie alla particolare configurazione delle alette è in grado di simulare un effetto Coanda nell'ambiente.

PS-CL ceiling chilled water cassette units, thanks to their modern design, setting flexibility, easy maintenance and maximum silence represent the result of accurate researches in order to achieve an innovative product, perfect for every surrounding and interior design. They respond to the multiple aesthetic and functional needs. The dimensions fit in the false-ceiling panels modularity. They are available in two different sizes 600x600 mm (PS050- PS094) and 1200x600 mm (PS100-154). In addition we have introduced a NEW version with 4 rows coil, which allows to obtain more efficiency, by increasing the capacities up to 20% more.

Finally we are proposing an innovative model of hydronic cassette unit: the **PS-CLH** characterized by a special vertical extension of the chassis and projected in such a way as to allow condensation to drain naturally, by avoiding the installation of a condensate pump. These units are suitable for the installation in environments where particular hygienic-sanitary requirements are necessary, where a low noise level is required and where it is important to simplify the maintenance procedures (hospitals, nursing, school, libraries ..). In our range we present the option with AC motors, the **PS-CL** model or with EC motors, the **PS-CLE** model. The version with EC motors saves up to 50% energy compared to the standard version. Besides the standard ABS panel, we can also propose a painted metal panel with magnetic opening, able to simulate a Coanda effect in the environment, thanks to the special configuration of the fins.

PS-CL Wasser-Deckenkassetten sind das Ergebnis einer sorgfältiger Analyse die zur Erlangung eines Artikels der eine moderne und innovative Technik umfaßt. Vorzüge dieses Produkts sind: ein modernes Design das sich an jeder Umgebung und Dekor eignet; Anpassungsflexibilität; Einfachheit der Installation und der Wartung; maximale Geräuschlosigkeit; perfekte Abstimmung auf die modulare Deckenplatten. Diese Einheit ist in zwei Abmessungen erhältlich: Größe 600x600mm (PS050-094) und Größe 1200x600mm (PS100-154) und endlich haben wir jetzt die neue Version vorgestellt, die mit 4 Reihen Waermetuscher, die es Ihnen ermöglicht, viel höhere Erträge zu erreichen und die Leistung um 20% zu erhöhen.

Wir schlagen auch eine neue Version der Kassette vor: **PS-CLH**, die sich durch eine besondere vertikale Entwicklung des Chassis auszeichnet und so entwickelt wurde, dass sie den Kondensatabfluss auf natürliche Weise ermöglicht und somit die Installation einer Kondensatpumpe vermeidet. Diese Geräte eignen sich für die Installation in Umgebungen, wo die besondere hygienisch-sanitäre Anforderungen gestellt werden, in denen es notwendig ist, die Reduzierung von Wartungsarbeiten zu erleichtern oder wo ein niedriger Geräuschemissionswert erforderlich ist (Krankenhäuser, Altenheime, Schulen, Bibliotheken ...).

In unserem Bereich stellen wir die Version mit AC-Motoren, das Modell **PS-CL** oder mit EC-Motoren, das Modell **PS-CLE**. Die Ausfuerung mit EC-Motoren erlaubt eine Energieeinsparung bis zu 50% im Vergleich zu der standard Version. Außer das Standard ABS-Panel bieten wir auch ein Blechpaneel mit magnetischer Öffnung an, das nach der Installation einen Coanda-Effekt in der Umgebung simuliert.

PS-050/094



ABS

PS-100/154



ABS



METAL



HIGH MODEL

CARATTERISTICHE COSTRUTTIVE - CONSTRUCTION FEATURES - EIGENSCHAFTEN

Struttura realizzata in lamiera zincata, isolata internamente con materiale anticondensa e fonoassorbente; (su richiesta è disponibile una struttura in Aluzinc per l'uso in ambienti corrosivi).

Scambiatore a batteria piegata composta da pacco alettato in alluminio idrofilico e tubi in rame 2-4 attacchi; costituiti da 2, 3 o 4 ranghi.

Motoventilatore di tipo a rotore esterno costituito da girante radiale equilibrata con pale indietro in ABS e motore multivelocità monofase ad induzione (**versione AC mod. PS-CL**) e a commutazione elettronica (**versione EC mod. PS-CLE**). Modello ad alta tecnologia ed efficienza (marca Ebm-papst)

Pannello diffusore aria costruito da elementi in ABS bianco pressofuso colore RAL 9003; disponibile anche una versione in lamiera verniciata, che grazie alla sua particolare configurazione garantisce un effetto Coanda al flusso d'aria in uscita. Possibilità di scegliere una vasta gamma di colori. Il flusso d'aria è regolato dalle alette poste su quattro uscite simmetriche del pannello, regolabili manualmente.

Filtro aria in materiale plastico supportato da rete e cornice metallica (G3);

Gruppo scarico condensa corredato di pompa centrifuga accoppiata a galleggiante elettromeccanico dotato di contatto allarme. Garantisce un'altezza di sollevamento acqua condensata fino a 100 cm (marca Siccom).

Morsettiere elettrica compatta e provvista di fusibile di protezione ed installata con carter di protezione cavi. Accesso pratico e veloce direttamente dal pannello frontale, semplicemente sollevando la griglia.

Frame made of strong galvanized sheet with anti-condensation coating and sound-absorbing material; (on request an Aluzinc plate is available for use in corrosive environments)

Exchanger made of bent coil composed of hydrophilic aluminium finned and 2-4 connections copper pipes; consisting of 2, 3 and 4 rows.

Motorfan of external rotor type made of a balanced radial impeller with ABS backward curved fans and multi-speed induction motor (**AC version mod. PS-CL**) and multi-speed electronic commutation (**EC version mod. PS-CLE**); High technology and efficiency model (Ebm-papst brand)

Air diffusion panel composed of a white plastic ABS material with RAL 9003 color; available even the painted steel version which ensures Coanda effect air flow, thanks to its particular configuration. Possibility to choose from a wide range of colors. The air flow is regulated by the fins placed on four symmetrical panel outlets, manually adjustable

Air filter made of resistant plastic supported by metallic net and frame (G3 efficiency Class)

Condensation drain pump equipped with a centrifugal pump completed with electromechanical float (Siccom brand);

Electrical terminal board: compact and provided with protection fuse. Installed with cable protection cover. Quick and practical access directly from the front panel, simply by lifting the grid.

Das Gehäuse ist aus verzinktem Blech gebaut und ist innen mit schallschluckendem und kondenswasserfestem Material isoliert; (auf Wunsch wird eine Aluzink Platte verfügt für den Einsatz in korrosiven Umgebungen).

Wärmetauscher aus gebogener Wärmeaustauscher, bestehend aus hydrophilen Aluminiumlamellen und Kupferrohren mit 2-4 Anschlüssen; bestehend aus 2, 3 und 4 Reihen.

Außenrotor Motorlüfter mit dynamisch und statisch ausgewuchtetem Radiallaufrad mit "backward" Schaufeln aus ABS, und Multi-Speed-Einphasen-Induktionsmotor oder als Zubehör Elektronisch-Kommutiert-Motor (EC-Ausführung). Hochtechnologie und Effizienzmodell (Marke Ebm-papst).

Hauptpaneel aus weißem ABS gebaut, Farbe RAL 9003; der Luftzufluss wird durch die Lamellen reguliert, die sich an vier symmetrischen Ausgänge auf dem Paneel befinden und manuell einstellbar sind. Zur Anfrage auch in einer Blechausführung erhältlich lackiert, das aufgrund seiner besonderen Konfiguration einen Coanda-Effekt auf den austretenden Luftstrom garantiert. Möglichkeit, eine breite Palette von Farben zu wählen.

Luftfilter aus Kunststoff mit Metall-Netz und Metall-Rahmen unterstützt (G3 Effizienzklasse).

Kondensatpumpe gekoppelt mit elektromechanischem Schwimmerschalter mit Alarmkontakt. Sie garantiert eine Kondenswasserhöhe von bis zu 100 cm.

Kompakter elektrischer Klemmenbrett mit Schutzsicherungen ausgestattet und mit Kabelschutzabdeckung installiert. Schneller und praktischer Zugang direkt von der Frontpaneel, einfach durch Anheben des Gitters.

DATI TECNICI - TECHNICAL DETAILS - TECHNISCHE DATEN

PS-CL 2T	2 TUBI/PIPES	050/2R	070/2R	080/3R	090/3R	080/4R	090/4R	100/3R	120/3R	150/3R	150/4R
Capacità totale freddo ¹ Total cooling capacity	KW (max)	2,39	3,51	5,06	5,72	6,16	6,84	7,21	8,83	10,85	12,99
	KW (med)	1,56	2,47	3,29	4,13	3,99	4,87	5,99	7,26	8,21	9,63
	KW (min)	1,45	1,48	2,98	3,04	3,64	3,61	5,55	6,01	6,47	7,52
Capacità sensib. freddo ¹ Sensible cooling capacity	KW (max)	1,79	2,46	3,38	3,78	4,07	4,57	4,67	5,74	6,98	8,24
	KW (med)	1,48	1,82	2,25	2,77	2,61	3,23	3,90	4,75	5,31	6,14
	KW (min)	1,31	1,32	2,06	2,08	2,37	2,36	3,62	3,96	4,22	4,79
Portata acqua ¹ Water flow	l/h (max)	410,7	602,42	868,82	981,66	1057,46	1173,25	1236,76	1515,59	1861,6	2228,13
Perdita di carico ¹ Pressure drop	kPa	1,1	2,4	6,1	8,0	7,6	4,4	12,4	9,3	15,6	34
Capacità caldo ² Heating capacity	KW (max)	3,41	4,78	6,25	7,03	7,15	8,06	8,43	10,46	12,72	14,22
	KW (med)	2,72	3,47	4,06	5,04	4,50	5,62	6,95	8,53	9,49	10,38
	KW (min)	2,42	2,45	3,69	3,73	4,06	4,07	6,42	7,03	7,42	7,98
Portata acqua ² Water flow	l/h (H)	410,07	602,42	868,82	981,66	1057,46	1173,25	1236,76	1515,59	1861,6	2228,13
Perdita di carico ² Pressure drop	kPa	1	2,1	5,60	7,40	7,00	4,1	11,3	8,6	14,6	32
Portata aria Air flow	m ³ /h(max)	500	750	800	910	800	910	1000	1270	1550	1550
	m ³ /h(med)	400	500	480	610	480	610	800	1000	1100	1100
	m ³ /h(min)	340	340	430	430	430	430	730	800	830	830
Livello pressione sonora Sound pressure level	dB (A) (H/M/L)	39/32/23	44/36/24	45/37/31	47/41/32	45/37/31	47/41/32	41/32/26	47/41/32	51/45/33	51/45/33
Alimentazione Power supply	V/Ph/Hz	210-230/1/50-60									
Potenza assorbita Absorbed power	W (max)	35	63	75	78	75	78	85	110	150	150
Corrente assorbita Absorbed current	A (max)	0,16	0,28	0,35	0,34	0,35	0,34	0,39	0,58	0,67	0,67
Connessioni idriche Water connections	Nr. x "	2 x 3/4" F									
Dimensioni unità/Unit sizes Dimen. pannello/ Panel sizes	mm (L-P-H)	570x570x250 (620x620x30)						1170x570x250 (1220x620x30)			
Peso totale/Total weight	Kg	18	18	19	19	19	19	38	38	38	38

PS-CL 4T	4 TUBI/PIPES	054/2R+1	084/2R+1	094/2R+1	094/3R+1	124/2R+1	154/2R+1	154/3R+1
Capacità totale freddo ¹ Total cooling capacity	KW (max)	2,97	4,08	4,56	5,72	6,93	8,59	10,82
	KW (med)	2,23	2,80	3,38	4,13	5,80	6,66	8,21
	KW (min)	2,01	2,58	2,57	3,04	4,90	5,38	6,50
Capacità sensib. freddo ¹ Sensible cooling capacity	KW (max)	1,95	2,63	3,00	3,78	4,47	5,48	6,91
	KW (med)	1,47	1,82	2,24	2,77	3,76	4,27	5,26
	KW (min)	1,33	1,67	1,72	2,08	3,18	3,46	4,19
Portata acqua ¹ Water flow	l/h (max)	510,02	700,32	782,96	981,66	1189,10	1473,64	1856,28
Perdita di carico ¹ Pressure drop	kPa	12,5	28,9	14,6	8,00	15,0	27,1	29,7
Capacità caldo ⁴ Heating capacity	KW (max)	4,77	6,27	6,84	6,84	10,26	12,17	12,17
	KW (med)	3,66	4,39	5,19	5,19	8,69	9,06	9,60
	KW (min)	3,31	4,06	4,06	4,06	7,43	7,87	7,87
Portata acqua ⁴ Water flow	l/h (H)	419,34	550,37	600,77	600,77	901,3	1068,56	1068,56
Perdita di carico ⁴ Pressure drop	kPa	8,6	16,9	20	20	72,2	40,9	40,9
Portata aria Air flow	m ³ /h(max)	570	800	910	910	1270	1550	1550
	m ³ /h(med)	390	480	610	610	1000	1100	1100
	m ³ /h(min)	340	430	430	430	800	830	830
Livello pressione sonora Sound pressure level	dB (A) (M/H/L)	39/32/23	45/37/31	47/41/32	47/41/32	47/41/32	51/45/33	51/45/33
Alimentazione Power supply	V/Ph/Hz	210-230/1/50-60						
Potenza assorbita Absorbed power	W (max)	35	75	78	78	110	150	150
Corrente assorbita Absorbed current	A (max)	0,19	0,35	0,34	0,34	0,58	0,67	0,67
Connessioni idriche Water connections	Nr. x "	4 x 3/4" F						
Dimensioni unità/Unit sizes Dimen. pannello/ Panel sizes	mm (L-P-H)	570x570x250 (620x620x30)				1170x570x250 (1220x620x30)		
Peso totale/Total weight	Kg	19,5	19,5	19,5	19,5	39	39	39

Reference conditions:

- 1: water temperature 7/12°C, air temperature 27°C d.b. - 19°C w.b.
- 2: water temperature IN 50°C, air temperature 20°C
- 3: sound pressure level measured in closed room with 0,4s reverberation time, at 1m distance.

*:absorbed power and current tested with digital-electronic counter mod. IME CONTO D2
- 4 pipes version: water temperature IN 70°C, OUT 60°C, air temperature 20°C

Functioning limits:

- max temperature IN water 80°C
- max working water pressure 10 bar

Condizioni di riferimento:

- 1: temperatura acqua 7/12°C, temperatura aria 27°C b.s. 19°C w.u.
- 2 : temperatura acqua IN 50°C, temperatura aria 20°C
- 3: livello di pressione sonora misurata in ambiente chiuso con tempo di riverberazione pari a 1 m di distanza

*:Potenza e corrente assorbita misurate con contatore digitale elettrico mod. IME CONTO D2
- Versione 4 tubi: temperatura acqua IN 70°C, OUT 60°C, temperatura dell'aria 20°C

Limiti di funzionamento:

- temperatura massima acqua IN 80°C
- massima pressione di esercizio: 10 bar

VERSION WITH EC-BRUSHLESS MOTOR

PS-CLE 2T		070/2R	090/3R	090/4R	150/3R	150/4R
Capacità totale freddo ¹ Total cooling capacity	KW (10V)	4,32	6,07	7,29	11,24	13,49
	KW (6V)	2,88	4,01	4,74	9,77	11,60
	KW (2V)	1,27	1,89	2,17	6,41	7,44
Capacità sensib. freddo ¹ Sensible cooling capacity	KW (10V)	2,99	4,01	4,86	7,22	8,56
	KW (6V)	2,06	2,69	3,14	6,29	7,38
	KW (2V)	1,04	1,28	1,40	4,17	4,73
Portata acqua ¹ Water flow	l/h (10V)	741,75	1041,15	1251,27	1928,31	2314,19
Perdita di carico ¹ Pressure drop	kPa	3,5	9,0	5	16,7	36,6
Capacità caldo ² Heating capacity	KW (10V)	5,85	7,47	8,60	13,20	14,80
	KW (6V)	3,96	4,90	5,46	11,39	12,63
	KW (2V)	1,94	2,29	2,43	7,34	7,88
Portata acqua ² Water flow	l/h (10V)	741,75	1041,15	1251,27	1928,31	2314,19
Perdita di carico ² Pressure drop	kPa	3,1	8,3	4,6	15,7	34,6
Portata aria Air flow	m ³ /h (10V)	980	980	980	1620	1620
	m ³ /h (6V)	590	590	590	1360	1360
	m ³ /h (2V)	250	250	250	820	820
Livello pressione sonora Sound pressure level	dB(A) (10/6/2V)	48/34/18	48/34/18	48/34/18	51/44/26	51/44/26
Alimentazione Power supply	V/Ph/Hz	210-230/1/50-60				
Potenza assorbita Absorbed power	W (10V)	41	45	45	85	85
Corrente assorbita Absorbed current	A (10V)	0,36	0,42	0,42	0,55	0,55
Connessioni idriche Water connections	Nr. x "	2 x 3/4"F				
Dimensioni unità/Unit sizes Dimen. pannello/ Panel sizes	mm (L-P-H)	570x570x250 (620x620x30)			1170x570x250 (1220x620x30)	
Peso totale/Total weight	Kg	18	19	19	38	38

PS-CLE 4T		094/2R+1	094/3R+1	154/2R+1	154/3R+1
Capacità totale freddo ¹ Total cooling capacity	kW (10V)	4,82	6,39	8,87	11,20
	kW (6V)	3,3	4,26	7,80	9,75
	kW (2V)	1,58	2,05	5,33	6,43
Capacità sensib. freddo ¹ Sensible cooling capacity	kW (10V)	3,16	4,11	5,66	7,15
	kW (6V)	2,19	2,76	4,99	6,23
	kW (2V)	1,12	1,35	3,43	4,14
Portata acqua ¹ Water flow	l/h (10V)	826,76	1095,85	1521,64	1922,55
Perdita di carico ¹ Pressure drop	kPa	16,2	34,3	28,8	31,8
Capacità caldo ⁴ Heating capacity	kW (10V)	7,19	7,19	12,54	12,54
	kW (6V)	5,08	5,08	11,12	11,12
	kW (2V)	2,73	2,73	7,80	7,80
Portata acqua ⁴ Water flow	l/h (10V)	631,63	631,63	1101,24	1101,24
Perdita di carico ⁴ Pressure drop	kPa	22,1	22,1	43,4	43,4
Portata aria Air flow	m ³ /h (10V)	980	980	1620	1620
	m ³ /h (6V)	590	590	1360	1360
	m ³ /h (2V)	250	250	820	820
Livello pressione sonora Sound pressure level	dB(A) (10/6/2V)	48/34/18	48/34/18	51/44/26	51/44/26
Alimentazione Power supply	V/Ph/Hz	210-230/1/50-60			
Potenza assorbita Absorbed power	W (10V)	45	45	85	85
Corrente assorbita Absorbed current	A (10V)	0,42	0,42	0,55	0,55
Connessioni idriche Water connections	Nr. x "	4 x 3/4"F			
Dimensioni unità/Unit sizes Dimen. pannello/ Panel sizes	mm (L-P-H)	570x570x250 (620x620x30)		1170x570x250 (1220x620x30)	
Peso totale/Total weight	Kg	19,5	19,5	39	39

Reference conditions:

- 1: water temperature 7/12°C, air temperature 27°C d.b. - 19°C w.b.
- 2: water temperature IN 50°C, air temperature 20°C
- 3: sound pressure level measured in closed room with 0,4s reverberation time, at 1m distance.

*:absorbed power and current tested with digital-electronic counter mod. IME CONTO D2
- 4 pipes version: water temperature IN 70°C, OUT 60°C, air temperature 20°C

Functioning limits:

- max temperature IN water 80°C
- max working water pressure 10 bar

Condizioni di riferimento:

- 1: temperatura acqua 7/12°C, temperatura aria 27°C b.s. 19°C b.u.
- 2 : temperatura acqua IN 50°C, temperatura aria 20°C
- 3: livello di pressione sonora misurata in ambiente chiuso con tempo di riverberazione pari a 1 m di distanza

*:Potenza e corrente assorbita misurate con contatore digitale elettrico mod. IME CONTO D2
- Versione 4 tubi: temperatura acqua IN 70° C, OUT 60°C, temperatura dell'aria 20°C

Limiti di funzionamento:

- temperatura massima acqua IN 80°C
- massima pressione di esercizio: 10 bar



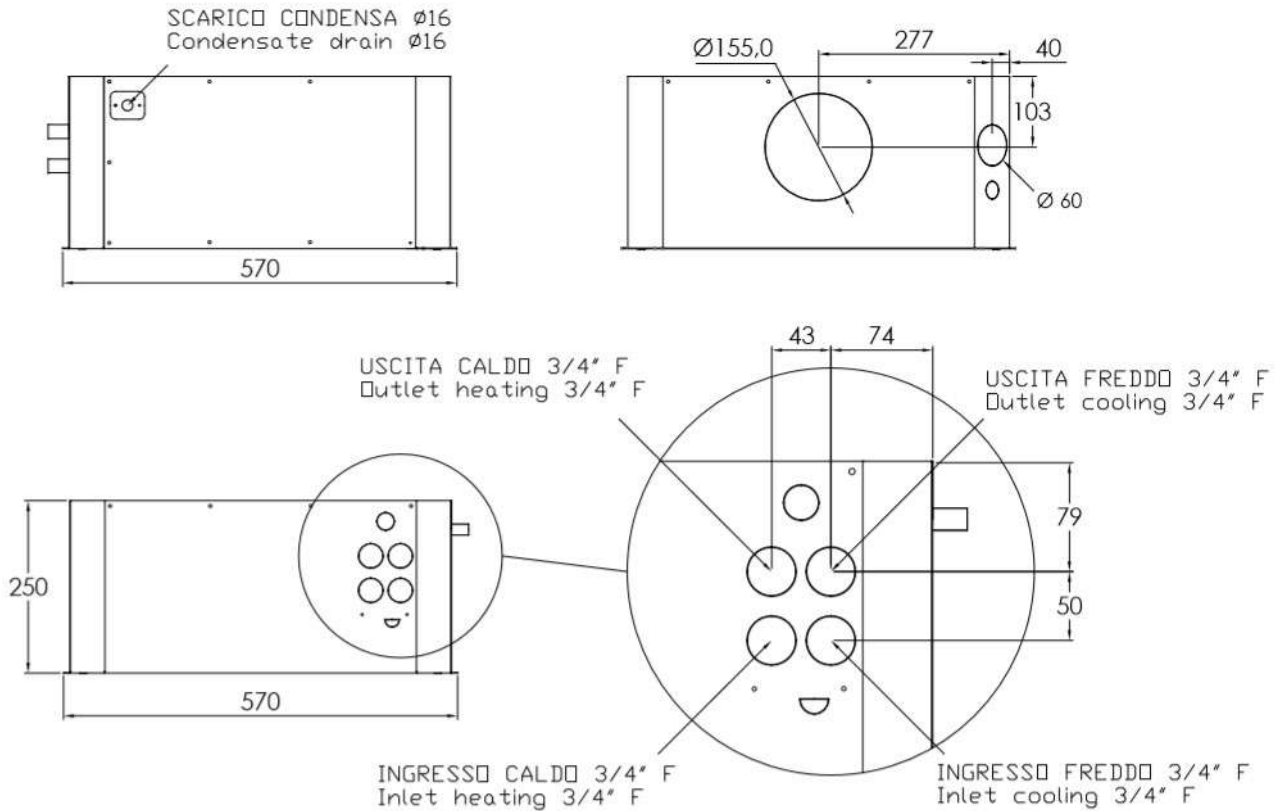



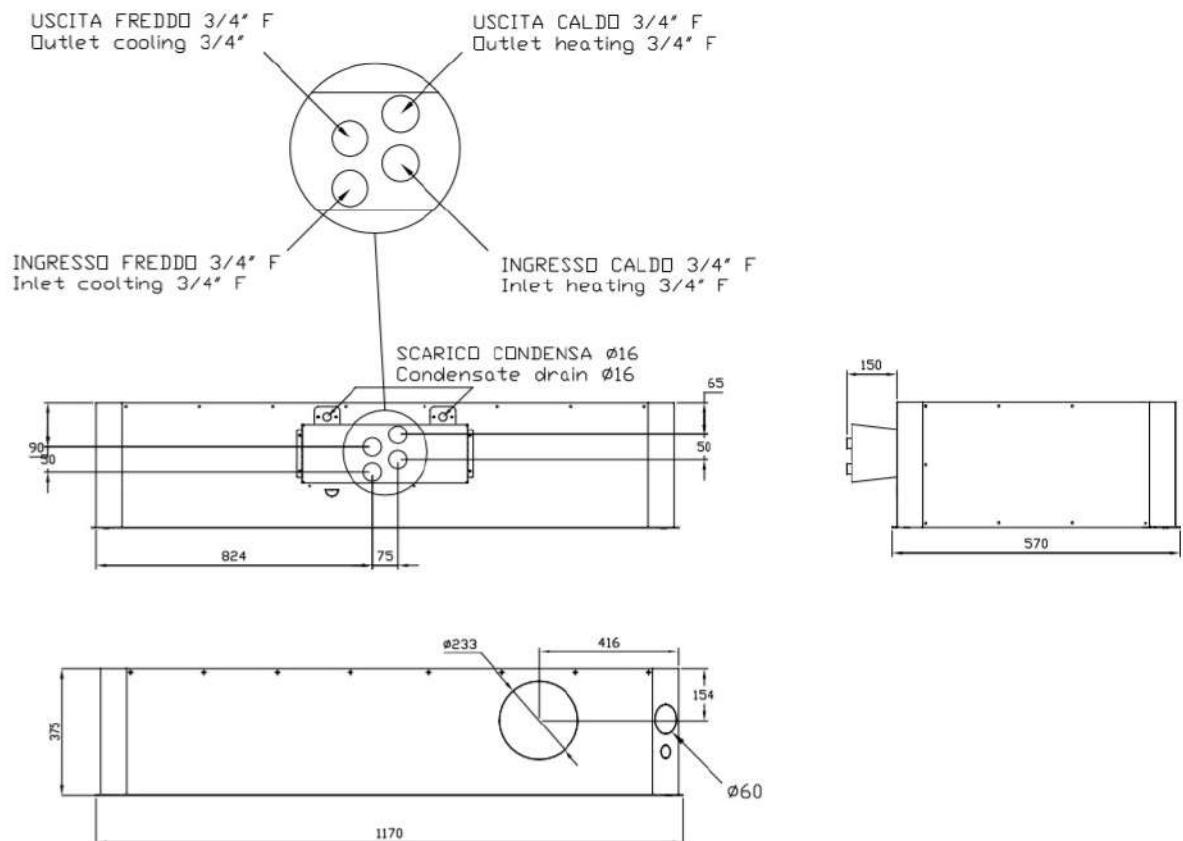











PS 050/094-CL DIMENSIONI - DIMENSIONS - ABMESSUNGEN











PS 100/154-CL DIMENSIONI - DIMENSIONS- ABMESSUNGEN



ACCESSORI - OPTIONS – ZUBEHOER

	TER.ANA	Termostato a muro analogico o a bordo macchina Wall analogic thermostat or built in version
	TER.DIG	Termostato a muro con display digitale Wall thermostat with display
	TER.DIG.D	Termostato a muro con display digitale idoneo anche per versione a bordo macchina. Wall thermostat with display suitable for the built-in version too.
	TER.BUS	Termostato a muro con display digitale e controllo ModBus Wall thermostat with display and ModBus control
	TER.TOUCH	Termostato a muro con display "Touch screen" Wall thermostat with touch screen display
	TER.TOUCH.EC	Termostato a muro con display "Touch screen" idoneo per versione con motore EC Wall thermostat with touch screen display suitable for EC motor version
	TER.EC	Termostato a muro per controllo motore EC Wall thermostat for EC motor control
	TER.EC.ANA	Termostato a muro analogico per comando motore EC Wall analogic thermostat for EC motor control
	KIT.TEL	Kit per controllo con telecomando IR (solo scheda e ricevitore) IR remote control kit (print board + receiver only)
	KIT.TEL.EC	Kit telecomando per EC (solo scheda +ricevitore) Infrared remote control kit (print board + receiver) for EC version
	TEL	Telecomando ad infrarossi IR remote control
	IDP	Interfaccia di potenza (controllo di 4 unità con 1 termostato) Power interface (4 units controlled by 1 thermostat)
	ATT.230/24	Attuatore elettrotermico ON-OFF (230V o 24V) ON-OFF electro-thermal actuator (230V or 24V)
	ATT.MOD	Attuatore modulante 0-10V 0-10V modulating actuator
	KIT.RES	Kit resistenza elettrica 230V con varie potenze 230V electric heater kit with several sizes
	VAL.2V.3/4 VAL.3V.3/4	Valvola 2 o 3 vie 3/4" montata (senza attuatore) Installed 3/4" 2 or 3 way valve (without actuator)
	VAL.DIN	Valvola di bilanciamento dinamico Dynamic balancing valve
	VAL.SFE.1/2	Kit valvole a sfera 1/2" F-F (2 pezzi) Ball valve kit 1/2" F-F (2 pieces)

	EST.1/2	Kit tubi flessibili/estensibili inox 1/2" M-F (2 pezzi) Flexible and extensible steel pipes kit 1/2" M-F (2 pieces)
	BAC.VAL1	Bacinella ausiliaria per valvole (versione singola) Auxiliary drain pan for valve (single version)
	BAC.VAL2	Bacinella ausiliaria per valvole (versione doppia) Auxiliary drain pan for valve (double version)
	FL.RIN	Flangia presa aria rinnovo Fresh air flange
	FL.AIR	Flangia presa aria locale attiguo Adjacent room air flange
	PAN.RAL	Pannello con colorazione RAL a richiesta Painted panel with RAL color on demand
	COVER METALLO	Cornice in metallo per installazione esterna cassetta. Metal covering for cassette external installation.

A decorative graphic consisting of several overlapping, wavy, translucent blue lines that flow across the middle of the page, creating a sense of movement and depth. The lines are more concentrated on the left and right sides, tapering towards the center.

PST Clima Srl - Via Pietro Candiano, 8 – 36016 Thiene (VI) ITALY
+39 0445-540348 - export@pstclima.it - www.pstclima.it